



# electrónica de precisión, s.a.

C./ Galileu, 17 Polígono Industrial Can Estella  
E-08635 Sant Esteve Sesrovires  
BARCELONA

Tel.: +34 93 774 69 10  
Fax.: +34 93 774 65 00  
e-mail: epsa@edep.com  
http://www.edep.com



## Lamp Assembly Reference 302

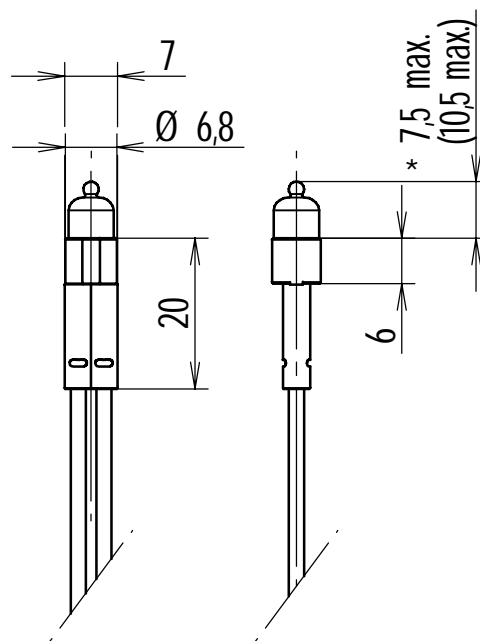

\* dimensions only valid, when equipped with glowlamp

Tolerances unless otherwise stated:  $\pm 0.2$

Scale: 1:1

This insulated indicating assembly is an evolution and improvement of loose lamp assemblies often insulated by sleeves. It can be equipped with any usual lighting mean, like neon glowlamps, incandescent filament lamps or light emitting diodes (L.E.D.).

Its housing can be manufactured in transparent or opaque colours in different thermoplastic materials and resistances to temperature, The lead wires are flexible, with cross section of 0,5mm<sup>2</sup> and insulated with PVC, silicone, a.s.o. and can be equipped with terminals and other finishes.

Please consult us.

The assembly is used for backlighting behind a protection like a lens, diffuser, a.s.o.. See also our offer in lenses and clips.