

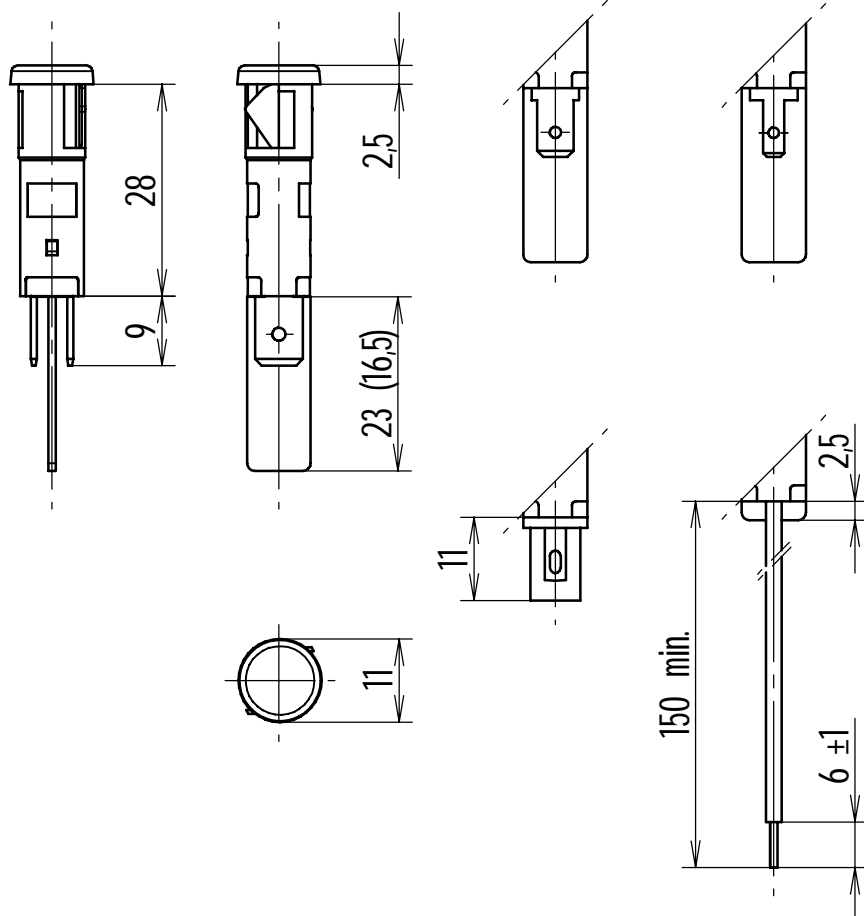

Indicator Light Type 557



Tolerances unless otherwise stated: ± 0.2

Scale: 1:1

Indicator light for building in.

Body with transparent coloured lens in one compact piece.

Different voltages, colours, connections, lighting technologies, resistances to temperature, conformity marks and also with special specifications available.

For details, please see our web page.

Recommended cutout

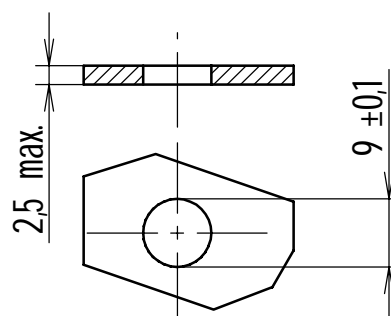

On introducing side no sharp edges!

Scale: 1:1



electrónica de precisión, s.a.

C./ Galileu, 17 Polígono Industrial Can Estella
E-08635 Sant Esteve Sesrovires
BARCELONA

Tel.: +34 93 774 69 10
Fax.: +34 93 774 65 00
e-mail: epsa@edep.com
http://www.edep.com



Technical specifications series 555, 557, 558, 559 and 560

(page 1 of 2)

This indicator light for building in is designed for general use and snap-in mounting to panel. The housing is composed of two thermoplastic pieces, the socket, and the housing itself with his lens, which is available in transparent colours and incorporates the fixing elements. In the socket are placed the connection and lighting means.

Following specifications are a guide for end users:

Connection means: Tabs (male terminals) 6.3 x 0.8, Tabs (male terminals) 4.8 x 0.8, Tabs (male terminals) 2.8 x 0.8, Tabs (male terminals) 2.8 x 0.5 (can also be used as solder terminals), Lead wires (cables).

Ambient temperature: To be used at an ambient temperature of maximum 85°C, maximum 120°C, maximum 150°C, maximum 170°C, please see "Notes and other technical specifications" the temperatures smaller than 170°C can be distinguished also by a key, where "A" stands for 120°C, "B" for 85°C and C for 150°C.

Rated voltage: 130V (can be used down to 110V), 250V (can be used down to 220V), for all voltages, please see "Lighting means".

Nature of supply: AC and DC, please see "Lighting means".

Lighting means: Neon glowlamp: for use either DC or AC.

Colours of lens: Red transparent, green transparent, amber (orange transparent), colourless (clear transparent) and blue transparent.

Colours of lighting means: Glowlamp: orange (normal type) with integrated fluorescent: green and blue.

Mounting hole: In addition to the recommended cutout, under request, the indicator can also be manufactured with a protection against rotation please ask for cutout details.

Applicable standard: VDE 0710 and, as far as applicable, IEC 598 (EN 60 598).

Conformity marks: 

Voluntary conformity marks: 

Notes and other technical specifications:

Nature of supply: This detail has to be indicated for execution 130V.

Life expectancy: Glowlamps normally have an average life of 30.000 hours at ambient temperature of 25°C. These values are given for AC supply and standard types. Please ask for specifications for other types.

Quench resistor: Indicator lights with glowlamp can light a little bit because of the proximity of induction, a lot of cables, or large currents in the mains, even if one pole of the source is disconnected. This phenomenon is solved either with two pole disconnection or incorporating an additional parallel resistor.

Other voltages: Under request also other voltages for different natures of supply can be offered.

Other colours of lens: Under request and price increase other lens colours can be manufactured.

Other lighting means: Also light emitting diodes (L. E. D.) and incandescent lamps available under request for small voltages.

The orange colour of glowlamp, normally red orange, is also available in pinky orange ask for special quote.

Brightness: Our indicator has high brightness light output. Other brightnesses available under request. The life expectancies vary from those specified above.

Cables: The cables are flexible lead wires of 0.5 mm² cross section and according to standards or certification institutes.



electrónica de precisión, s.a.

C./ Galileu, 17 Polígono Industrial Can Estella
E-08635 Sant Esteve Sesrovires
BARCELONA

Tel.: +34 93 774 69 10
Fax.: +34 93 774 65 00
e-mail: epsa@edep.com
<http://www.edep.com>



Technical specifications series 555, 557, 558, 559 and 560

(page 2 of 2)

Order Instructions

For orders, please indicate: Type reference, maximum temperature of use or its key, voltage, nature of supply (if voltage is smaller than 220V), colour of lens, lighting mean and his colour and connection means.

Examples: Indicator light type 560A, 250V, green transparent, green fluorescent glowlamp, lead wires (cables), or: Indicator light type 555, 150°C, 130V AC, red transparent, orange glowlamp, tabs 6.3 x 0.8.

Any special requeriment (f. e. specific plastic raw material, quench resistor and his ohmic value, special size or form for socket partition, other ambient temperature, other voltage, other lighting mean, a. s. o.) is considered a special execution and his supply and order identification has to be confirmed specially by us.

These details are necessary for the first order and to be in accordance with the prescriptions of product identification of the standard(s) and (or) of the certification institute(s).

For following orders this can be substituted by a code of ten numbers which we assign to all our products and coincides with our drawing number.