

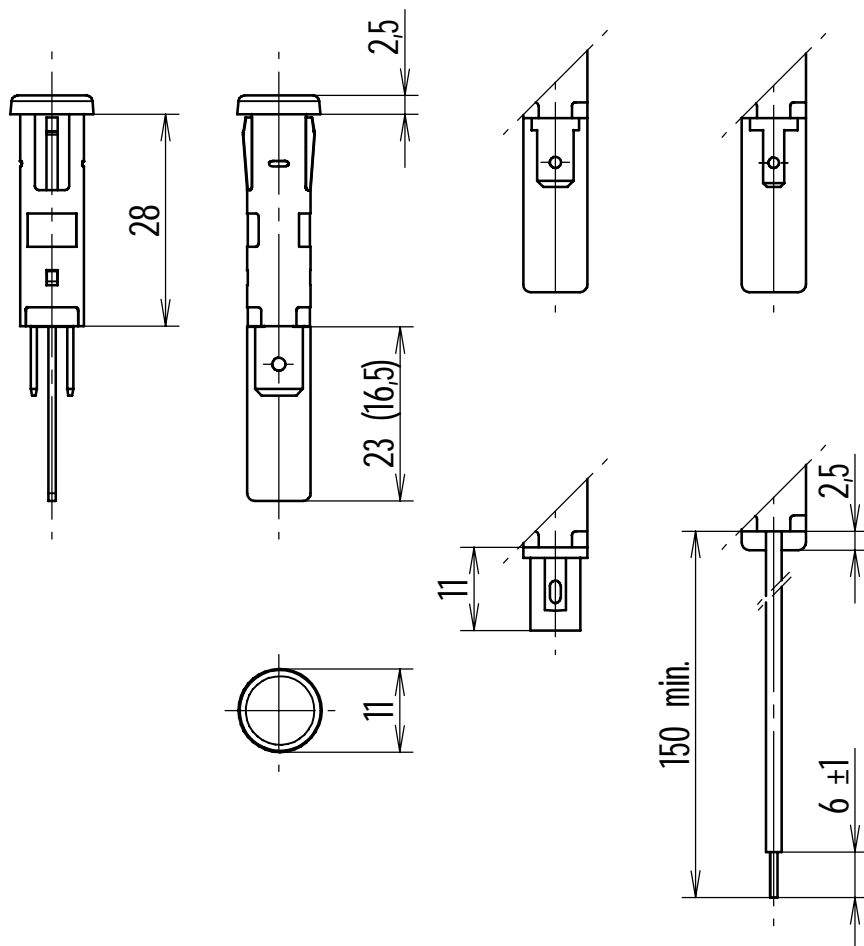

Indicator Light
Type 517



Tolerances unless otherwise stated: ± 0.2

Scale: 1:1

Indicator light for building in.

Body with transparent coloured lens in one compact piece.

Different voltages, colours, connections, lighting technologies, resistances to temperature, conformity marks and also with special specifications available.

For details, please see our web page.

Recommended cutout

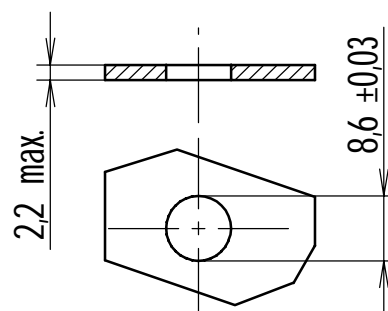

On introducing side no sharp edges!

Scale: 1:1



electrónica de precisión, s.a.

C./ Galileo, 17 Polígono Industrial Can Estella
E-08635 Sant Esteve Sesrovires
BARCELONA

Tel.: +34 93 774 69 10
Fax.: +34 93 774 65 00
e-mail: epsa@edep.com
http://www.edep.com



Technical specifications series 511,512,515, 577, 578 and 579

(page 1 of 2)

This indicator light for building in is designed for general use and snap-in mounting to panel. The housing is composed of two thermoplastic pieces, the socket, and the housing itself with his lens, which is available in transparent colours and incorporates the fixing elements. In the socket are placed the connection and lighting means.

Following specifications are a guide for end users:

Connection means: Tabs (male terminals) 6.3 x 0.8, Tabs (male terminals) 4.8 x 0.8, Tabs (male terminals) 2.8 x 0.8, Tabs (male terminals) 2.8 x 0.5 (can also be used as solder terminals), Lead wires (cables).

Ambient temperature: To be used at a ambient temperature of maximum 85°C, maximum 120°C, maximum 150°C, maximum 170°C, please see "Notes and other technical specifications" the temperatures smaller than 170°C can be distinguished also by a key, where "A" stands for 120°C, "B" for 85°C and C for 150°C.

Rated voltage: 6V, 12V, 24V, 130V (can be used down to 110V), 250V (can be used down to 220V), for all voltages, please see "Lighting means".

Nature of supply: AC and (or) DC, please see "Lighting means".

Lighting means L. E. D. (light emitting diode): for use at 6V, 12V and 24V DC or AC

Incandescent lamp: for use at 6V, 12V and 24V either DC or AC

Neon glowlamp: for use at voltages of 130V or higher, either DC or AC

Colours of lens: Red transparent, green transparent, amber (orange transparent), colourless (clear transparent) and blue transparent.

Colours of lighting means: L. E. D.: red, green, and amber

Incandescent lamp: white

Glowlamp: orange (normal type) with integrated fluorescent: green and blue

Applicable standard: VDE 0710 and, as far as applicable, IEC 598 (EN 60 598).

Conformity marks: 

Voluntary conformity marks:  and  for nearly all executions.

Notes and other technical specifications:

Nature of supply: This detail is not necessary to be specified for executions with higher voltage, but for 130V it is imperative. Also for executions 6V, 12V and 24V and equipped with L. E. D. it must be indicated (not necessary for incandescent lamp). The positive pole (anode) on the DC executions with L.E.D. is distinguished by a red lead wire (cable) or a terminal of brass (not plated).

Life expectancy: Light emitting diodes have an average life of 50.000 hours at ambient temperature of 25°C, incandescent lamps of 5.000 or 10.000 hours (depending on voltage) under same conditions and glowlamps normally 30.000 hours. These values are given for AC supply and standard types. Please ask for specifications for other types.

Quench resistor: Indicator lights with glowlamp can light a little bit because of the proximity of induction, a lot of cables, or large currents in the mains, even if one pole of the source is disconnected. This phenomenon is solved either with two pole disconnection or incorporating an additional parallel resistor.

Other voltages: Under request also other voltages for different natures of supply can be offered.

Other colours of lens: Under request and price increase other lens colours can be manufactured.

Other colours of lighting means: Specially for L. E. D. there are different colours available under request, as f. e. blue, white, yellow and different kinds of red, green and amber. The orange colour of glowlamp, normally red orange, is also available in pinky orange ask for special quote.

Ambient temperature of use: If the indicator light has to work in other ambient temperatures, ask for special quote. The executions of small voltage (6V, 12V, 24V) can only be supplied for a maximum temperature of use of 85°C, when equipped with L. E. D. when incorporating incandescent lamp, please consult for higher temperatures.

Brightness: Our indicator has high brightness light output. Other brightnesses available under request. The life expectancies vary from those specified above.

Cables: The cables are flexible lead wires of 0.5 mm² cross section and according to standards or certification institutes.

Chrome plated frontal: National standards have to be observed; in some countries the use of these pieces are not allowed.



electrónica de precisión, s.a.

C./ Galileu, 17 Polígono Industrial Can Estella
E-08635 Sant Esteve Sesrovires
BARCELONA

Tel.: +34 93 774 69 10
Fax.: +34 93 774 65 00
e-mail: epsa@edep.com
<http://www.edep.com>



Technical specifications series 511, 512, 515, 517, 577, 578 and 579

(page 2 of 2)

Order Instructions

For orders, please indicate: Type reference, maximum temperature of use or its key, voltage, nature of supply (if voltage is smaller than 220V), colour of lens, lighting mean and his colour, connection means and, if required, additional frontal.

Examples: Indicator light type 512A, 250V, green transparent lens, green fluorescent glowlamp, lead wires (cables), or: Indicator light type 511, 85°C, 12V DC, red transparent lens, L.E.D. red, tabs 6.3 x 0.8 and additional frontal.

Any special requirement (f.e. specific plastic raw material, quench resistor and his ohmic value, special size or form for socket partition, other ambient temperature, a.s.o.) is considered a special execution and his supply and order identification has to be confirmed specially by us.

These details are necessary for the first order and to be in accordance with the prescriptions of product identification of the standard(s) and (or) of the certification institute(s).

For following orders this can be substituted by code often numbers which we assign to all our products and coincides with our drawing number.