

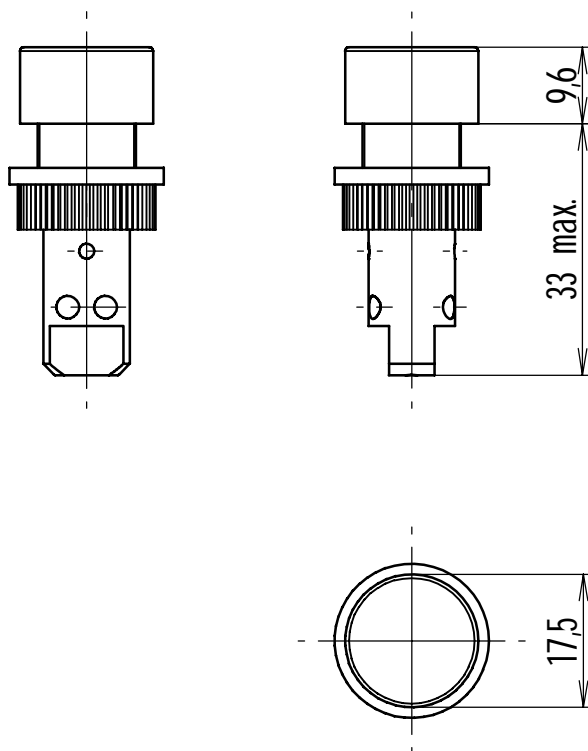

Indicator Light Type 521



Tolerances unless otherwise stated: ± 0.2

Scale: 1:1

Indicator light for building in, fixed by nut allows be fixed on large panel thicknesses.
Different voltages, colours and lighting technologies available.
For details, please see our web page.

Recommended cutout

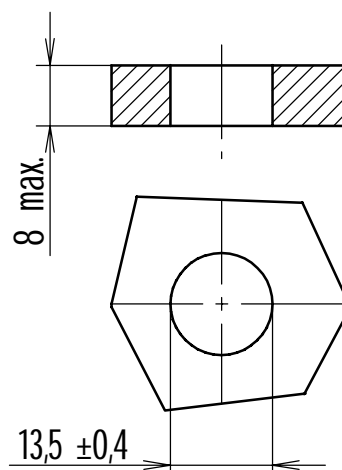

Scale: 1:1



electrónica de precisión, s.a.

C./ Galileu, 17 Polígono Industrial Can Estella
E-08635 Sant Esteve Sesrovires
BARCELONA

Tel.: +34 93 774 69 10
Fax.: +34 93 774 65 00
e-mail: epsa@edep.com
http://www.edep.com



Technical specifications series 521

This indicator light for building in is designed for general use and mounting by nut to panel, also with large thickness.

The housing is composed of two thermoplastic pieces, the socket, and the housing itself. The lens, screwed to the housing and incorporating a difuser, is available in transparent colours. In the socket are placed the connection and lighting means. The nut is screwed to the housing and insures the fixing

Following specifications are a guide for end users:

Connection means: Screw-type terminals (protected against accidental touch) allow connection of conductors having cross-sectional area of minimum 0.5 mm² and maximum 1.0 mm² (the protection is only effective, when conductors are stripped or crimped with end splices with a length of 5 mm).

Ambient temperature: To be used at a ambient temperature of maximum 55°C.

Rated voltage: 230V (can be used down to 220V) please see "Lighting means".

Nature of supply: AC and DC please see "Lighting means".

Lighting means: Neon glowlamp: for use either DC or AC.

Colours of lens: Red transparent, green transparent, amber (orange transparent), colourless (clear transparent) and blue transparent..

Colours of lighting means: Glowlamp: orange (normal type) with integrated fluorescent: green and blue.

Applicable standard: VDE 0710 and, as far as applicable, IEC 598 (EN 60 598).

Conformity marks: 

Voluntary conformity marks: Can be arranged under request

Notes and other technical specifications:

Life expectancy: The glowlamps used in these indicator lights have an average life of 10.000 hours at ambient temperature of 25°C. These values are given for AC supply and standard types. Please ask for specifications for other types.

Quench resistor: Indicator lights with glowlamp can light a little bit because of the proximity of induction, a lot of cables, or large currents in the mains, even if one pole of the source is disconnected. This phenomenon is solved either with two pole disconnection or incorporating an additional parallel resistor.

Other voltages: Under request also other voltages for different natures of supply can be offered.

Other lighting means: Also light emitting diodes (L. E. D.) and incandescent lamps available under request for small voltages.

Brightness: Our indicator has high brightness light output. Other brightnesses available under request. The life expectancies vary from those specified above.

Order Instructions

For orders, please indicate: Type reference, colour of lens, lighting mean and his colour.

Examples: Indicator light type 521, green transparent, green fluorescent glowlamp.

Any special requirement (f. e. quench resistor and his ohmic value, other voltage, other lighting mean, a. s. o) is considered a special execution and his supply and order identification has to be confirmed specially by us.

These details are necessary for the first order.

For following orders this can be substituted by a code of ten numbers which we assign to all our products and coincides with our drawing number.